

GEJ-1234

MANUAL FOR **ENGINE MEN**

44-TON DIESEL-ELECTRIC LOCOMOTIVE

(Serial No. 30132 and above)



AMERICAN LOCOMOTIVE COMPANY
GENERAL ELECTRIC COMPANY

SCHENECTADY, N. Y.

4.49' (1500)
U.S.A.

PRINTED IN

CONTENTS

Subject	Page
How a Diesel Electric Functions	5
General Data	6-7
Engineman's Position	8-9
Control Compartments	10-11
Gage Panel	12
Locomotive Operation	13-22
Automatic Alarms & Safeguards	22-23
Air Brake Operation	23-25
Multiple Locomotive Operation	26
Operating Under Unusual Conditions	27-30

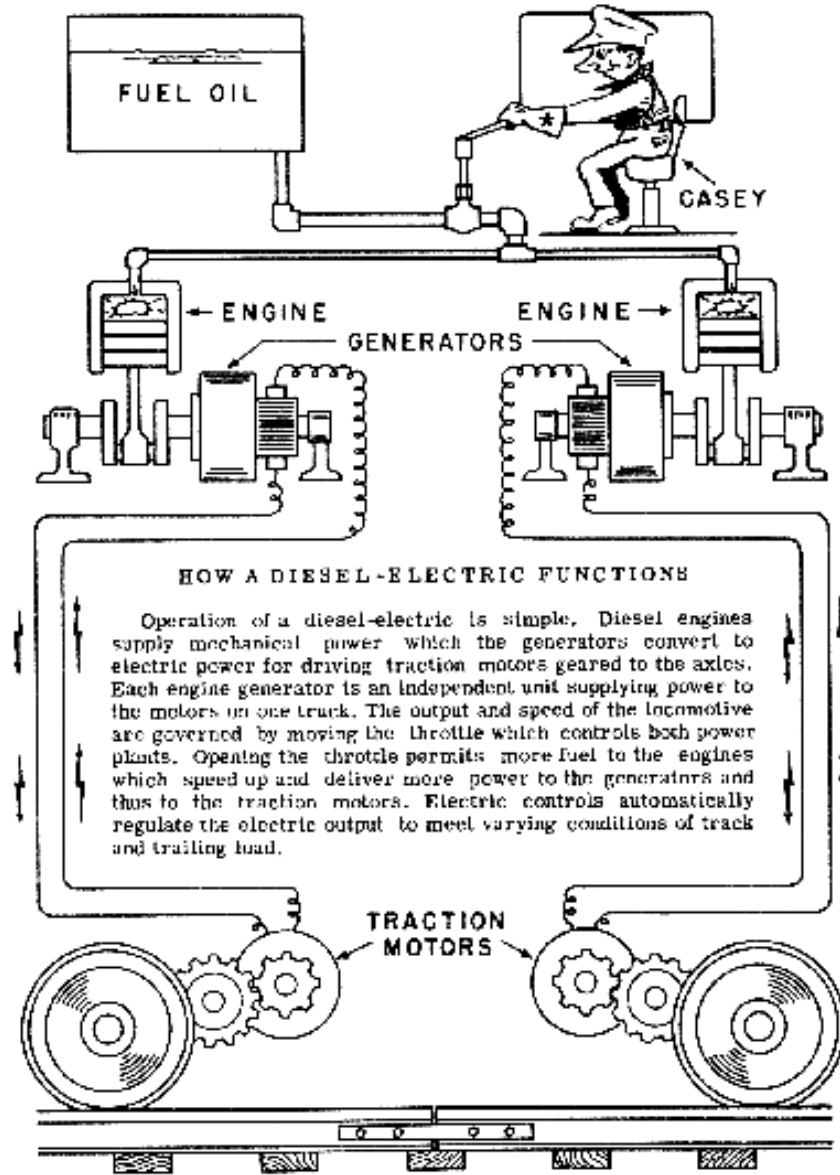

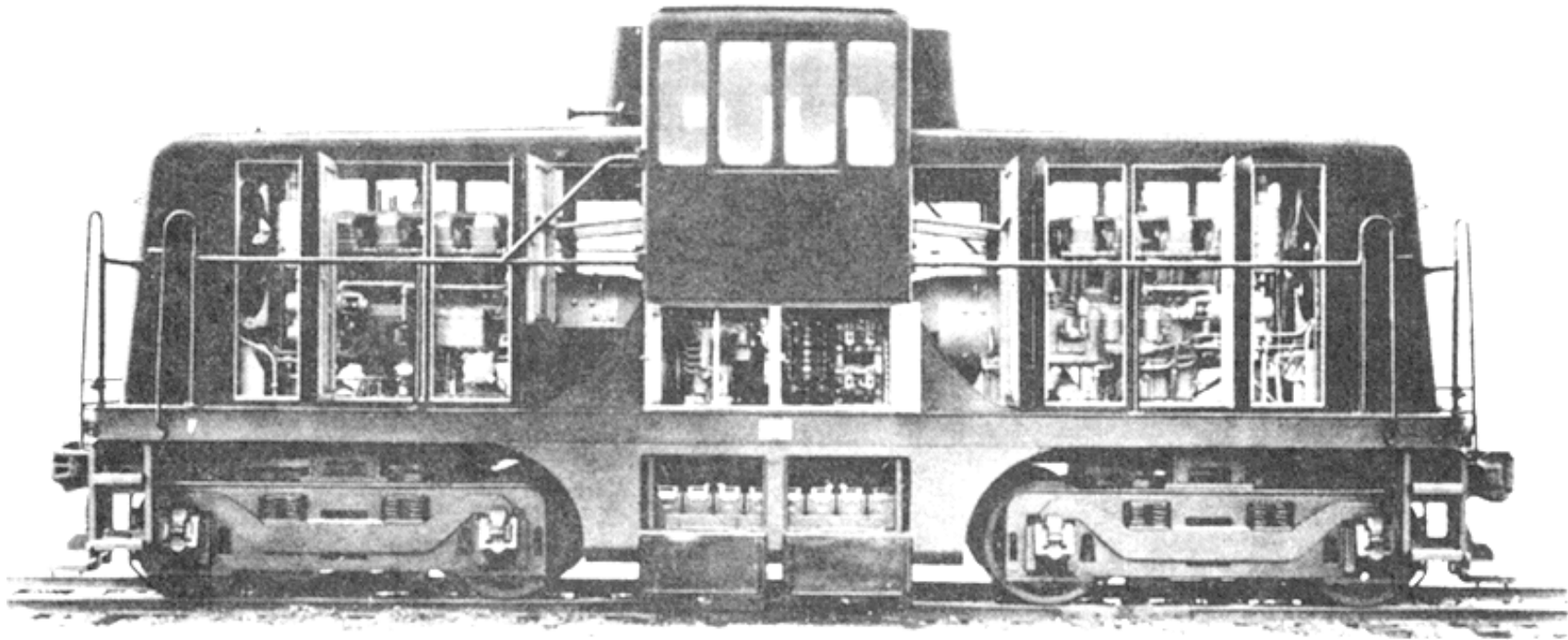

Weight in Working Order	88,000 Lb
Weight on Drivers, Fully Loaded	89,000 Lb
Maximum Operating Speed	35 Mph
Maximum Curve, Locomotive Alone	50-Ft Radius
Fuel Tank Capacity	250 U.S. GaL
Lubricating Oil Capacity (Per Engine)	50 U.S. Gal.
Cooling Water Capacity (Per Engine).....	40 U.S. GaL
Sand Box Capacity, Total .	8 Cu Ft
Tractive Effort Starting, 30% Adhesion	26,400 Lb

Fig. 1. 44-Ton Diesel-electric Locomotive.

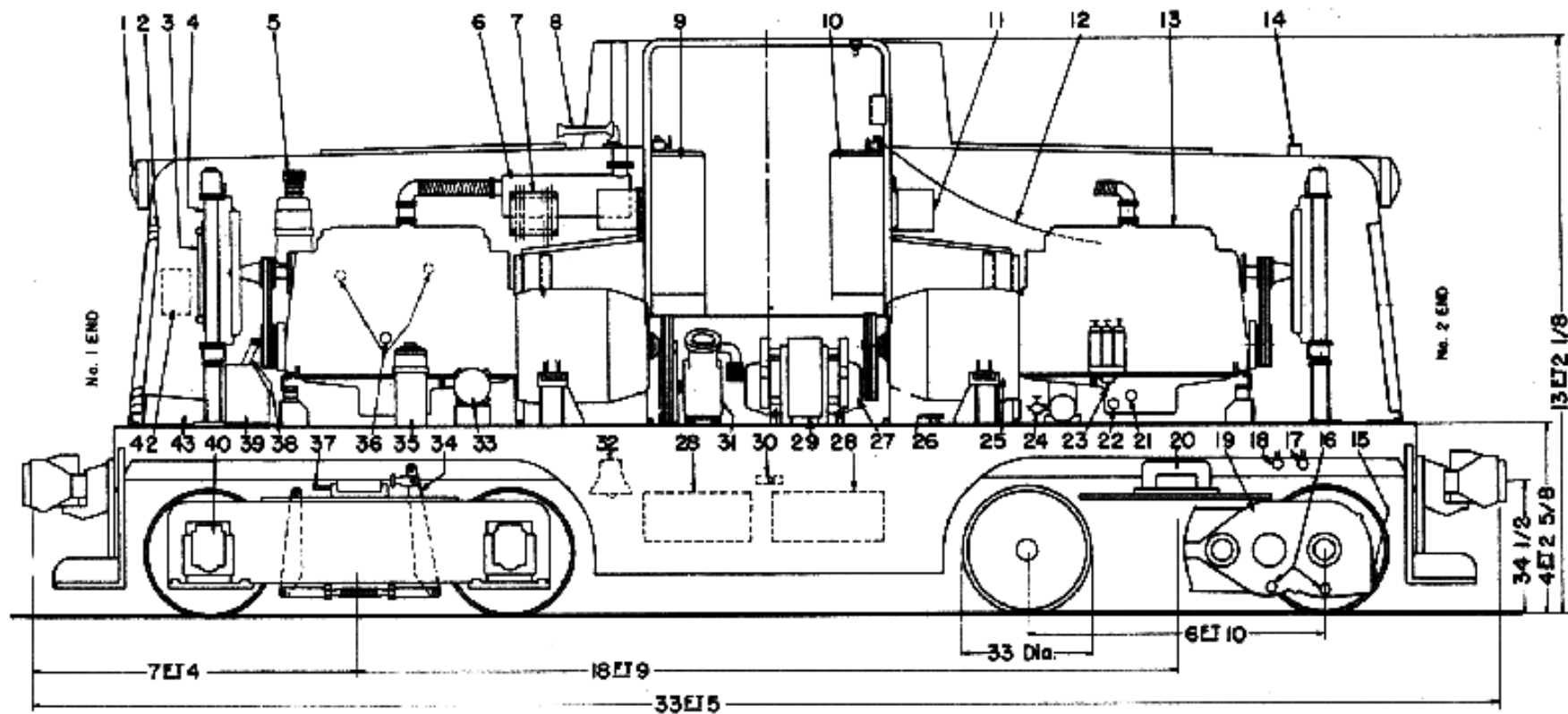

- | | | |
|------------------------------------|---|---|
| 1. Headlight | 15. Gear-unit Oil-level Plug | 29. Reverser |
| 2. Winter Front | 16. Gear-unit Drain Plugs | 30. Fuel-oil Tank Sump and Drain |
| 3. Lube-oil Cooler | 17. Lube-oil Tank Drain | 31. Air Compressor |
| 4. Radiator | 18. Cooling-water Filling Funnels and Drain | 32. Bell |
| 5. Engine Air Intake | 19. Traction Motor and Gear Unit | 33. Fuel-oil Filter |
| 6. Exhaust Muffler | 20. Side Bearing | 34. Brake Rigging |
| 7. Kerosene Tank | 21. Diesel-engine Upper-sump Drain | 35. Engine Water Heater |
| 8. Air Horn | 22. Diesel-engine Lower-sump Drain | 36. Diesel-engine Water-manifold Drain Plug |
| 9. Control Compartment - Forward | 23. Lube-oil Filter Drain | 37. Center Plate Filling Pipe |
| 10. Control Compartment - Rear | 24. Lube-oil Filter Drain | 38. Lube-oil Tank Filling Pipe |
| 11. Resistor Panel | 25. Traction Generator | 39. Lube-oil Tank |
| 12. Engine Shut-down Control Cable | 26. Fuel-oil Filling Pipe | 40. Journal Box |
| 13. Diesel Engine | 27. Exciter-auxiliary Generator | 41. Traction-motor Air Intake Box |
| 14. Antifreeze Filler Pipe | 28. Batteries | 42. Sand Box |

Fig. 2. Location of Apparatus, Fillers, Drains and Dimensions.

ENGINEMAN'S POSITION

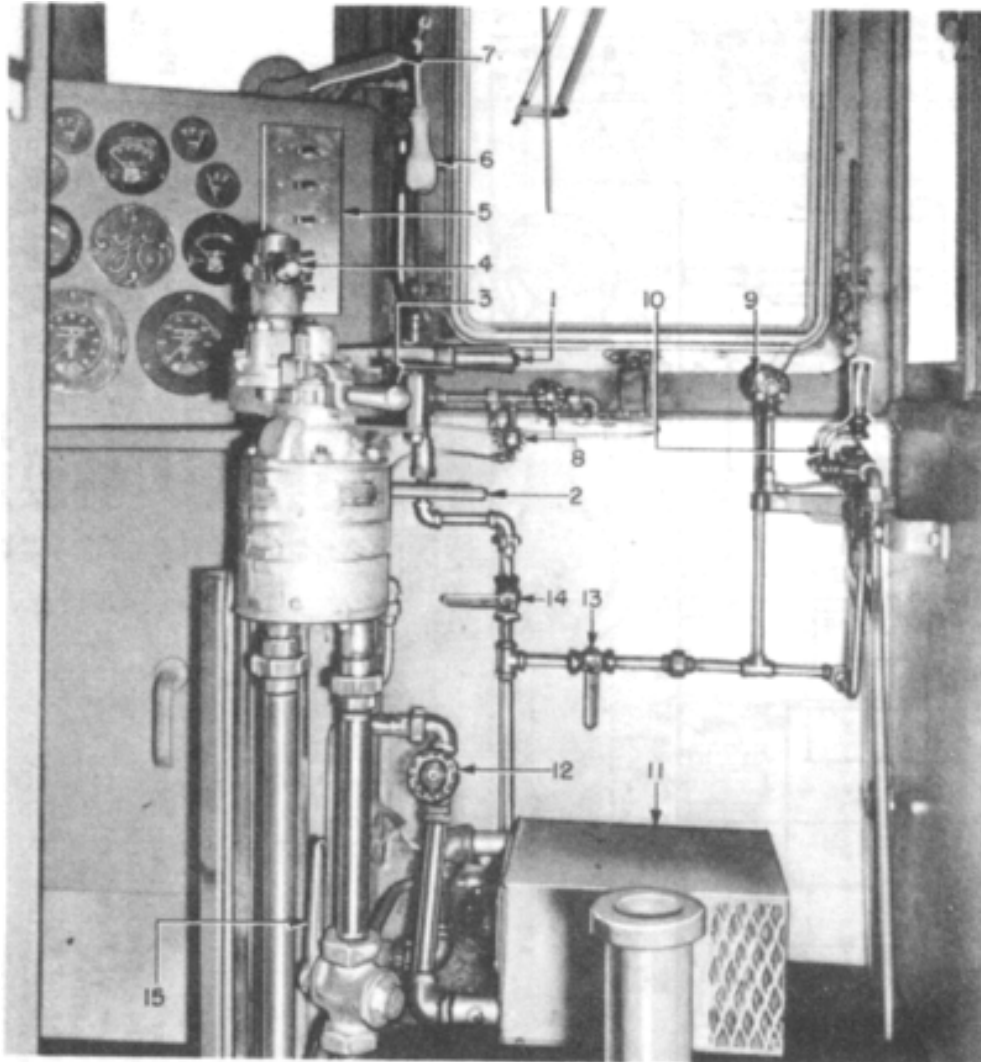

1. Throttle Handle
2. Reverse Handle
3. Automatic Brake-Valve Handle
4. Independent Brake -Valve Handle
5. Gage Panel
6. Horn Valve Handle
7. Shutter Control Handle
8. Window Wiper Valve
9. Bell Ringer Valve
10. Sander Valve
11. Cab Heater
12. Cab Heater Shut-off Valve
13. Cut-out Cock for Sander and Bell Ringer
14. Cut-out Cock for Window Wiper and Horn
15. Double Heading Cut-outCock

Fig. 3. Engineman's Position (Single-unit Locomotives).

ENGINEMAN'S POSITION

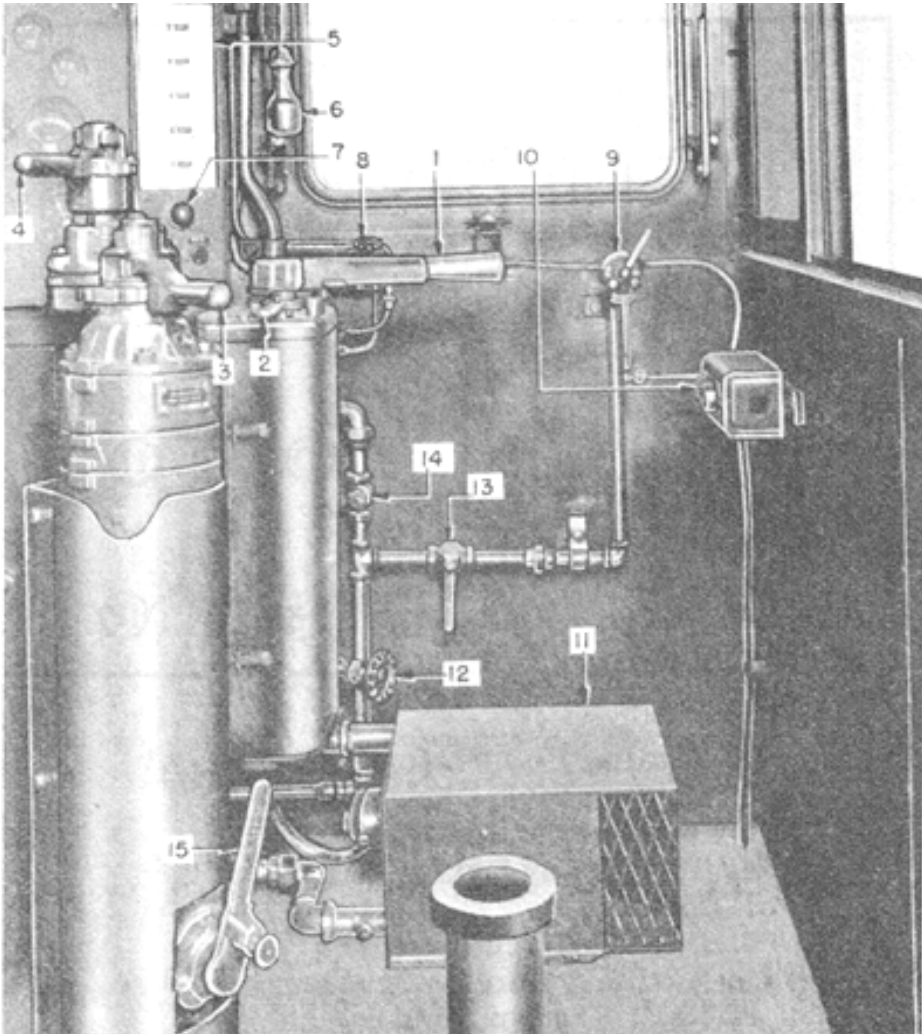

1. Throttle Handle
2. Reverse Handle
3. Automatic Brake-Valve Handle
4. Independent Brake-Valve Handle
5. Gage Panel
6. Horn Valve Handle
7. Engine Indicating Light
8. Window Wiper Valve
9. Bell Ringer Valve
10. Sander Switch
11. Cab Heater
12. Cab Heater Shut-off Valve
13. Cut-out Cock for Bell Ringer
14. Cut-out Cock for Window Wiper and Horn
15. Three Position Cut-out Cock

Fig. 4. Engineman's Position (Multiple-unit Locomotive).

CONTROL COMPARTMENTS

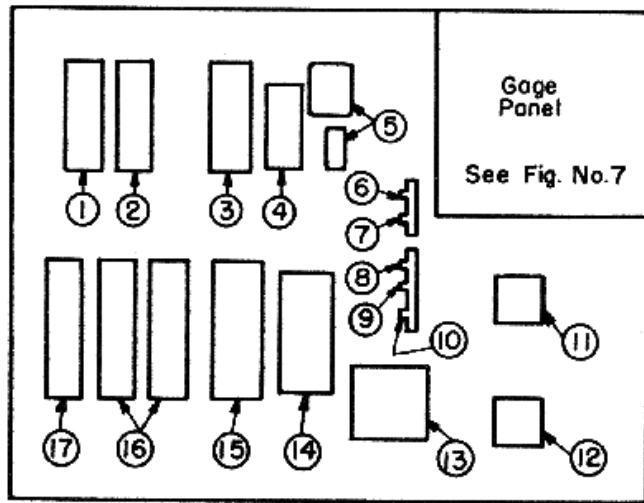

1. Auxiliary Generator Contactor, A1
2. Exciter Field Contactor, EF1
3. Reverse Current Relay, RC 1
4. Time Delay Relay, TD
5. Fuses
6. Control Circuit Breaker
7. Auxiliary Circuit Breaker
8. No. 1 Exciter Field Switch
9. No. 1 Motor Cut-out Switch, C01
10. No. 2 Motor Cut-out Switch, C02
11. Feed Valve
12. Reducing Valve
13. Throttle Control Switch, TC
14. Battery Switch, DS
15. Voltage Control Relay, X1
16. Motor Line Contactors, P1-P2
17. Engine Starting Contactor, GS1

Fig. 5. Foreword Control Compartment.

CONTROL COMPARTMENTS

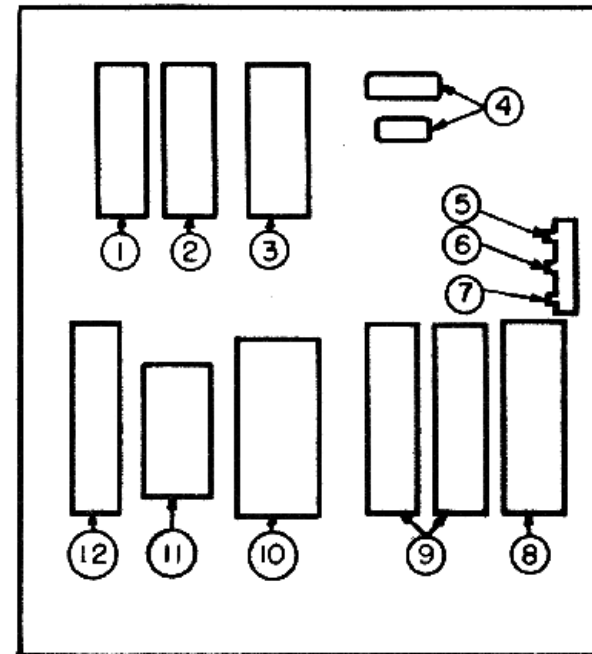

1. Auxiliary Generator Contactor, A21
2. Exciter Field Contactor, EF21
3. Reverse Current Relay, RC 2
4. Fuses
5. No. 2 Exciter Field Switch
6. No. 3 Motor Cut-out Switch, C03
7. No. 4 Motor Cut-out Switch, C04
8. Voltage Control Relay, X21
9. Motor Line Contactors, P3-P4
10. Field Shunting Relay, FS
11. Field Shunting Drop-out Relay, CR
12. Engine Starting Contactor, GS21

Fig. 6. Rear Control Compartment.

LOCOMOTIVE OPERATION

PREPARATIONS FOR OPERATION

1. Check supply of lubricating oil, fuel oil, cooling water and sand.
2. Inspect engine, generator, and control compartments for waste or tools that may have been inadvertently left near moving parts or electric connections.
3. Make sure all switches are OPEN.
4. Place reverse handle in NEUTRAL and throttle handle in IDLE.
5. See that double-heading or brake-pipe three-position cutout cock handle, located under the brake valve, is in the horizontal (CUT-IN) position.

STARTING THE DIESEL ENGINES

1. Close battery and control switches.
2. Close control circuit breaker.
3. Push start button for No. 1 engine, hold it until engine is firing regularly, and then release button. Watch lubricating oil gage to see that pressure builds up.

NOTE: On locomotives equipped for multiple-unit operation it is necessary to pull the triangular handle marked PULL WHEN STARTING ENGINE at the same time the ENGINE START button is pushed. This handle renders the emergency engine shutdown feature inoperative and should be used only to permit starting the engines.

Hold the handle until the engine lubricating-oil pressure has come up to its normal value; then release the handle. The starting button may be released as soon as the engine is firing regularly.

4. Repeat step 3 with start button for No. 2 engine.

NOTE: In cold weather it may be necessary to advance the throttle beyond the IDLE position and to use the engine water heater. See ENGINE -WATER HEATER.

CAUTION: Never press ENGINE -START button while engine is running; also, never press both ENGINE -START buttons at the same time.

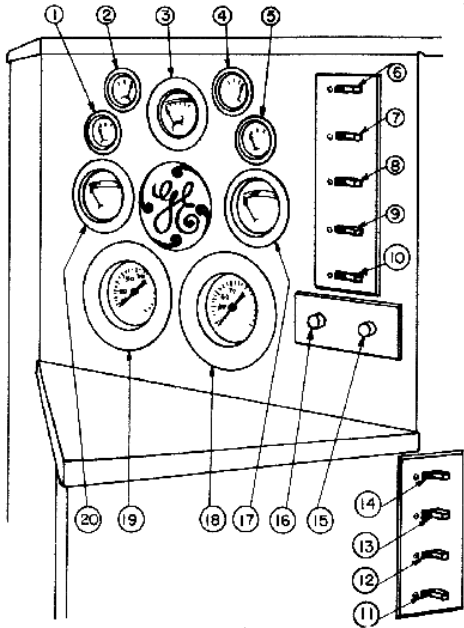

- | | |
|--|--|
| 1. Oil Pressure, Engine #2 | 12. Class & Marker Lights Switch |
| 2. Water Temperature, Engine #2
Engine #2 | 13. Rear Headlight - Bright & Dim -
Switch |
| 3. Battery Voltmeter | 14. Front Headlight - Bright & Dim -
Switch |
| 4. Water Temperature,
Engine # 1 | 15. No. 1 Engine Start Button |
| 5. Oil Pressure, Engine #1 | 16. No. 2 Engine Start Button |
| 6. Control Switch | 17. Load Indicator - Generator # 1 |
| 7. Cab-Heater Switch | 18. Brake Cylinder & Brake Pipe
Air Gage |
| 8. Cab-Light Switch | 19. Main Reservoir & Equalizer
Reservoir Air Gage |
| 9. Front Headlight Switch | 20. Load Indicator - Generator #2 |
| 10. Rear Headlight Switch | |
| 11. Gage Light Switch | |

Fig. 7. Gage Panel

LOCOMOTIVE OPERATION

PREPARATIONS FOR MOVING LOCOMOTIVE

1. Allow engines to idle until water temperature reaches 120 F and main-reservoir air pressure builds up to between 130 and 140 pounds.

NOTE: To build up air pressure quickly after engines are warm, advance the throttle to give 3/4 full engine speed. Return the throttle to IDLE position when air pressure is up.

2. Operate air brakes to see that shoes apply and release.
3. Observe the operation of all belt-driven machines and other equipment to see that they function properly.

4. Close auxiliary circuit breaker if lights on cab heater are to be used.

5. See that the battery is being charged as indicated by the battery voltmeter.

6. Provide proper ventilation for the diesel engines by adjusting winter fronts and opening or closing the roof hatches. See POWER PLANT VENTILATION AND TEMPERATURE CONTROL.

ENGINE IDLING

Prolonged idling and especially speeding an unloaded engine will cause poor combustion. This results in excessive formation of carbon on injector tips and contributes to lubricating-oil dilution. .

MOVING LOCOMOTIVE

1. Make independent air brake application. Release hand brake.

2. Test FORWARD and REVERSE sanding. 3. Place throttle handle in IDLE.

4. Move reverse handle for desired direction of movement.

5. Release air brakes.

6. Open the throttle just out of the IDLE position and wait for slack to be taken up; then advance the throttle steadily and as rapidly as desired up to the slipping point of the wheels. Throttle movements should be smooth and continuous; do not jerk throttle back and forth, and after locomotive has accelerated to the desired speed, ease back on the throttle to the point where the speed is maintained.

7. When starting on an ascending grade, do not release air brakes until throttle handle has been advanced sufficiently to prevent locomotive from drifting backward.

LOCOMOTIVE OPERATION

8. Do not exceed a speed of 35 mph.

9. If power fails on locomotive, move throttle to IDLE. Apply brakes.

LOAD INDICATOR

A load indicator is actually an ammeter with a special dial marked in bands of GREEN, YELLOW and RED instead of amperes.

The colors are proportioned to give an approximate indication of the character of service in which the locomotive can be used without danger of overheating the electric equipment.

The indicator pointer when in the GREEN band indicates that the load is safe for all classes of service.

The indicator pointer when in the YELLOW band indicates that the load is safe for switching and for short runs in transfer or haulage services.

The indicator pointer when in the RED band indicates that the load is safe only for switching and starting.

STOPPING LOCOMOTIVE

1. Move throttle handle to IDLE.

2. Apply brakes.

3. Move reverse handle to NEUTRAL.

NOTE: If power cannot be removed from traction motors by moving throttle to IDLE, open the CONTROL circuit breaker or the CONTROL switch.

REVERSING LOCOMOTIVE

1. Bring locomotive to a full stop. Never reverse locomotive while it is in motion.

LOCOMOTIVE OPERATION

2. Move reverse handle for opposite direction of motion. 3. Release brakes and open throttle.

STOPPING THE DIESEL ENGINES

1. Move the throttle to the IDLE position.
2. Pull button marked ENGINE STOP and hold it until the engine comes to a stop. Repeat for second engine.

LEAVING LOCOMOTIVE

1. Open all switches and circuit breakers.
2. Move reverse handle to NEUTRAL position.
3. Set hand brake.
4. Open main battery switch.
5. Close all doors, ventilators and windows. Make sure winter front and roof shutters are closed. If there is danger of freezing, drain entire cooling water system, or be sure there is sufficient antifreeze to protect against lowest anticipated temperature. See Fig. 2.

ENGINE-WATER HEATER

Locomotives operating in cold climates are provided with heaters to warm up the engines before starting.

The diesel engine has no ignition system and depends upon the heat developed by compression to make it fire. Therefore, after periods of shut-down during cold weather where the engine has cooled down to air temperature, there is danger of completely discharging the battery by continued cranking before the cylinders get warm enough to fire. To guard against this condition a heater is provided for the purpose of warming up the cooling water in the engine jacket.

To start the kerosene-type heater proceed as follows:

1. Make certain that there is sufficient kerosene in the supply tank.
2. Open the valve in the line between the bottom of the water heater and the engine water jacket. A thermostat shuts off the water circulation to the radiator.

LOCOMOTIVE OPERATION

3. Start the heater by lighting the wick and adjust for a clear blue flame. Readjust if necessary, after the heater has warmed up to avoid smoking. Make sure that the safety trip lever on the float chamber is in the down position. This lever should stay in the down position whenever the heater is in operation.

4. Do not attempt to start the engine until the heater has operated a sufficient time so that the engine cylinder block is warm to the touch.

5. After the engine starts, shut down the heater and close the valve in the line between the bottom of the water heater and the engine water jacket.

POWER-PLANT VENTILATION AND TEMPERATURE CONTROL

The engine cab is divided into two compartments: the diesel-engine compartment, and the traction-generator compartment. Air for ventilating the traction generator enters through louvers in the main-cab subbase and passes out through openings in the engine cab adjacent to the generator.

Air for ventilating the diesel engine is drawn in through an adjustable winter front in the end of the engine cab and passes out through adjustable shutters in the roof of the engine cab. The circulation of air in the engine compartment can be controlled by levers located in the main cab.

When operating, open one or both of the shutters in the roof of the engine cab depending on the maximum load to be hauled and the outside temperature. These hatches should require infrequent attention, since better control for minor variations in cooling-water temperature may be had by adjusting the winter front in the end of the engine cab.

OVERHEATING OF ENGINE

Do not stop engines immediately after a hard run. Circulation of the water depends upon the circulating pump and when the engine is shut down, the pump also stops. The iron masses in an engine pulling full load absorb sufficient heat to boil the water if the circulation stops. Let the engines idle for five minutes before shutting them down.

LOCOMOTIVE OPERATION

If, for any reason, the water supply has failed, do not turn water into the cylinders until they have become normally cool. The cylinder heads are liable to crack if they have become too hot and water is turned into them.

BATTERY-CHARGING EQUIPMENT

The auxiliary generator supplies the control and lighting load and charges the batteries.

Battery-charging equipment for each power plant consists of an auxiliary generator, belt driven from the main generator, a voltage-control relay, and a reverse-current relay.

ENGINE-STARTING EQUIPMENT

Each diesel engine is started by a traction generator running as a motor from storage-battery power. The generator is wound with a series-field starting winding. Pressing the start button closes an engine-starting contactor which connects the battery with this winding in the traction generator.

MAIN CIRCUITS

Main circuits for each power plant include the following equipment: Traction generator, traction motors, contactors for connecting the traction generator and traction motors, and a reverser for changing the direction of current in the traction motor fields.

Maximum engine utilization is obtained by connecting field-shunting resistors in parallel with the traction-motor fields at high locomotive speeds.

LOCOMOTIVE OPERATION

GENERATOR FIELD

The generator shunt field is excited by a belt-driven exciter. This exciter has characteristics which enable the generator to deliver the full output of the engine to the traction motors over a wide range of locomotive speed.

"V" BELT DRIVES

The exciter-auxiliary generator and air compressor are driven by "V" belts from a pulley on the main generator shaft. Adjustment of belt tension is provided by moving the air compressor on its base, which changes the distance between pulley centers. The radiator fan is driven by "V" belts from a pulley on the front of the engine crankshaft. A screw arrangement is used as a belt tightener to obtain the desired adjustment. Refer to ENGINE INSTRUCTIONS. A fairly accurate guide for determining the correct tension is to make the adjustment so that the belts can be depressed about one to one and one-half inches by applying finger pressure at a point midway between the pulleys.

INSPECTION DURING OPERATION

Correction of minor irregularities reported at the end of each run will usually avert major repairs later. Watch the level of the oil and water. Once a shift make visual inspection of running gear for loose or dragging parts. Investigate unusual noises or odors immediately.

Overheated journal boxes will smoke and smell. When this happens, stop locomotive, open cover, let journal box cool, loosen waste and remove charred waste. Report to maintainer for correction.

Truck troubles are usually evidenced by jars or vibrations. On such occasions, look for broken springs in motor suspension or in trucks, excessively worn center plate, badly shelled, worn, or chipped wheels. Badly worn, poorly lubricated, or broken gear teeth will cause clatter in gear cases. Emergency stops may cause flat spots, shelling on wheels or brake shoes and should be reported to the maintainer for correction.

LOCOMOTIVE OPERATION

GAGES AND INSTRUMENTS

Normal lubricating-oil pressure, when the engine is warm, is between 30 and 35 pounds. If pressure is lost in any engine during multiple-unit operation the engine-indicating light on the gage panel will go out in both units.

Cooling water temperature should be between 160 F and 180 F. During multiple-unit operation the engine-indicating light will go out in both units if the water temperature of any engine exceeds 190 F.

The battery voltmeter should show charge while the engine is *running*. If it shows continual discharge, report to maintainer for correction. The battery voltmeter on the gage panel shows the voltage output in the battery circuit.

When the needle is in the first long RED band it indicates that the battery is in bad condition or is being discharged. Report to maintainer for correction if needle makes prolonged indication in lower RED band of the dial.

When the needle is in the WHITE band (while the engine is running) it indicates that the battery is either in a low state of charge or being discharged. The normal open circuit voltage on a 32-cell battery is 64 volts with the engine shutdown and no load on the battery.

When the needle is in the GREEN band it indicates that the battery is receiving normal charge.

NOTE: The pointer may be in the white band just below the green for a short time after the engine has been started.

When the needle is in the RED band beyond the GREEN band it indicates that the battery is being overcharged. Report this condition to maintainer.

Air-brake pressure should be in accordance with customer standards.

LOCOMOTIVE OPERATION

DOUBLE-HEADING SINGLE-UNIT LOCOMOTIVE

On the second locomotive move double-heading brake-pipe cut-out cock handle to a (CUT-OUT) position with the handle vertical and parallel with brake-valve pipe. Leave independent and automatic brake-valve handles in RUNNING POSITION. Brakes on the second locomotive will then operate as those in train. The operator on the second locomotive can prevent a brake application or release brakes on his locomotive by moving the independent brake handle to RELEASE position and back to RUNNING position. This should be done only if wheels slide.

DOUBLE-HEADING MULTIPLE-UNIT LOCOMOTIVE

On the second locomotive move the three-position brake-pipe cut-out cock handle (located under brake valve) to the vertical (INTERMEDIATE) position. Leave independent and automatic brake-valve handles in RUNNING position. Brakes on the second locomotive will then operate as those in train. The operator on the second locomotive can prevent a brake application or release the brakes on his locomotive by moving the independent brake handle to RELEASE position and back to RUNNING position. This should be done only if wheels slide.

MOVING SINGLE-UNIT LOCOMOTIVE DEAD

1. Move throttle handle to IDLE and place reverse handle in NEUTRAL.
2. Open circuit breakers and all switches including battery switch.
3. Move the double-heading brake-pipe cut-out cock handle (located under brake valve) to (CUT-OUT) position with the handle vertical and parallel with brake-valve pipe. Open the dead-engine fixture (located near distributing valve) by turning handle to a right angle with pipe.
4. Close all doors, ventilators and windows. If there is danger of freezing, drain entire cooling-water system, or be sure there is sufficient anti-freeze to protect against lowest anticipated temperature. See Fig. 2.

NOTE: DO NOT EXCEED 35 MPH SPEED LIMIT. If the haul is long, have maintainer pull pinions from the traction motors.

LOCOMOTIVE OPERATION

MOVING MULTIPLE-UNIT LOCOMOTIVE DEAD

1. Move throttle handle to IDLE and place reverse handle in NEUTRAL.
2. Open circuit breakers and all switches including battery switch.
3. Move the three-position brake-pipe cut-out cock handle (located under brake valve) to its extreme clockwise position; to do this it is necessary to pull out on the spring-loaded stop pin until the handle can be moved over the stop lug. Open the dead engine fixture (located on distributing valve) by turning the handle to a horizontal position.
4. Close all doors, ventilators and windows. If there is danger of freezing, drain entire cooling-water system, or be sure there is sufficient antifreeze to protect against lowest anticipated temperature. See Fig. 2.

NOTE: DO NOT EXCEED 35 MPH SPEED LIMIT. If the haul is long have maintainer pull pinions from the traction motors.

AUTOMATIC ALARMS AND SAFEGUARDS

ENGINE SHUT-DOWN DEVICES

On a multiple-unit locomotive the engine-indicating light will be on when the engines are running and the cooling-water temperature is below 190 F. If locomotives are connected in multiple the light will go out in both units if an engine shutdown due to low lubricating-oil pressure or high cooling water temperature is encountered in any engine. Pull the button marked ENGINE STOP if the automatic shut-down devices do not stop the engine.

If the emergency fuel-trip handle is pulled in either the locomotive cab or under the right side of the platform it will shut off the fuel at the tank and stop the engine after the supply lines have been exhausted.

CIRCUIT BREAKERS

One circuit breaker is used to protect each of the following:

1. Control circuits.
2. Auxiliary circuits.

AUTOMATIC ALARMS AND SAFEGUARDS

They are located in the forward control compartment (See Fig. 5) and operate in the same manner as a tumbler switch. The handle, when in the center position, indicates that the breaker has been tripped by a short circuit, an overload, or by shock. It is reset by first moving the handle approximately two degrees beyond the OFF position, then to the ON position.

FUSES

The following fuses are located in the control compartment:

1. One 60-ampere fuse for main battery circuit.
2. Two 35-ampere fuses, one in each battery-charging circuit.
3. Two 4-ampere fuses, one in each battery-charging circuit.

AIR - BRAKE OPERATION

USING AIR BRAKES

The following instructions cover, in a general way, the proper method of handling the 14EL equipment in service, but do not apply rigidly to all individual cases or conditions. Special instructions are usually issued by each railroad to cover its own recommended practice in accordance with local operating conditions.

Operation of 14EL air-brake equipment is practically the same as 6ET equipment used on steam locomotives. The automatic valve applies brakes on both the locomotive and the train.

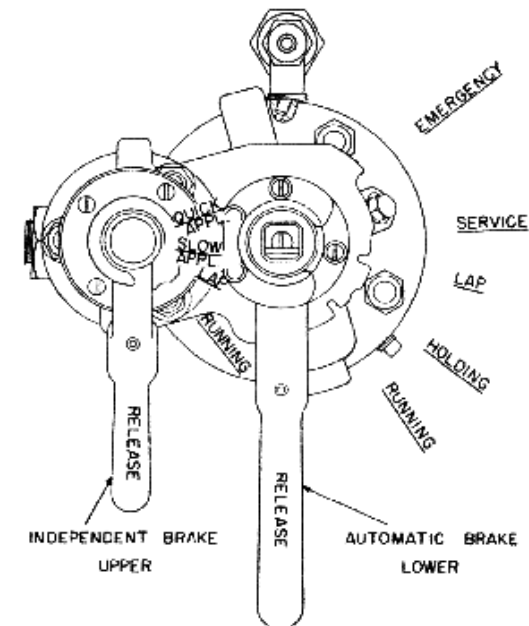

Fig. 8. Air - brake Handles.

AIR - BRAKE OPERATION

The independent valve applies brakes only on the locomotive. Unless a brake application is desired, carry both brake handles in the RUNNING position. See Fig. 8.

CHARGING TRAIN -BRAKE SYSTEM

With normal minimum reservoir pressure, the train brake system can be charged by leaving the automatic brake handle in RUNNING position. Faster charging may be accomplished by holding the automatic brake handle in the RELEASE position until the brake -pipe gage shows that the desired pressure has been obtained. When using the RELEASE position for charging, watch the brake-pipe gage and do not overcharge the system.

NORMAL AUTOMATIC BRAKE APPLICATION

1. Move automatic-brake handle to SERVICE position. This gradually reduces brake-pipe pressure and applies the brakes. The brake application is proportional to the reduction in brake pipe pressure up to a certain limit where maximum braking is obtained.

2. When a sufficient rate of braking is obtained, move the automatic brake handle to LAP position. This brake pressure will be maintained on all brakes as long as the handle remains in this position. If additional braking is required, move the handle back into SERVICE position and then to LAP when braking rate reaches the desired amount.

EMERGENCY AUTOMATIC BRAKE APPLICATION

Move handle to EMERGENCY position. This will give the quickest and heaviest application of brakes.

RELEASE OF AUTOMATIC BRAKES

1. Move automatic-brake handle to HOLDING position. This will release train brakes, but keep locomotive brakes applied. Never depend on air brakes to hold locomotive on a grade when air compressor is shut down.

2. Move handle to RUNNING position, to release both train and locomotive brakes.

AIR - BRAKE OPERATION

3. If only a partial release is required, move automatic brake handle back to LAP when the required amount of release is obtained. With long trains the rate of brake release and recharging of train brake system can be accelerated by moving handle into RELEASE position a short time before moving handle into HOLDING or RUNNING position.

NOTE: Hold the handle in RELEASE position a short time only; otherwise the train brake system may be overcharged. The automatic brake valve will hiss when in RELEASE position to warn the operator. During switching service there is little occasion to use the RELEASE POSITION.

APPLICATION OF LOCOMOTIVE BRAKES ONLY

1. Move independent brake handle to SLOW APPLICATION or QUICK APPLICATION, depending on the rate of brake application required. Do not use the independent brake to stop a long train.

2. When sufficient rate of braking is obtained, move independent brake handle to LAP position and this rate will be held. If additional braking is required, move handle back into APPLICATION position and then back to LAP

RELEASE OF LOCOMOTIVE BRAKES ONLY

1. Move independent brake handle into RUNNING position to release locomotive brakes that have been applied by an independent application.

2. Locomotive brakes applied with automatic brake handle can be released by moving independent brake handle to RELEASE position. This position can also be used to release an independent application at a faster rate than in RUNNING position.

NOTE: Holding handle in RELEASE position more than momentarily will overcharge the locomotive system and locomotive brakes cannot be applied with automatic brake handle. A spring return prevents leaving independent brake handle in RELEASE position and air escapes from independent brake valve to warn operator.

MULTIPLE LOCOMOTIVE OPERATION

Locomotives in the following instructions are referred to as "controlled" locomotive and "controlling" locomotive. The locomotive from which the operator controls both locomotives is called "controlling" locomotive. The locomotive which is not controlled by an operator in the cab is called the "controlled" locomotive.

PREPARATION FOR OPERATING

1. Start the engines in each locomotive as described under STARTING THE DIESEL ENGINES.
2. Couple the locomotives.
3. Set hand brakes on both locomotives.
4. Make air and electric connections between locomotives.

NOTE: Diesel engines may be left running while making air and electrical couplings if the reverse handle is in NEUTRAL.

5. Remove reverse handle and brake-valve handles from "controlled" locomotive.
6. On the "controlled" locomotive, move the three-position brake-pipe cut-out cock handle (located under brake valve) to a vertical (INTERMEDIATE) position. On the "controlling" locomotive, move the three-position brake-pipe cut-out cock handle to a horizontal (CUT-IN) position.

MOVING LOCOMOTIVES

Observe all gages and indicators, making sure that each power plant is operating properly. Proceed the same as for single -unit operation.

The engine -indicating light in each locomotive will go out if an engine shut-down or high-water temperature occurs in either locomotive during multiple-unit operation.

Make occasional inspection of "controlled" locomotive. Make necessary adjustment to winter front or roof shutters to control engine cooling water temperature.

OPERATING UNDER UNUSUAL CONDITIONS

OPERATING WITH ONE POWER PLANT ONLY

Shut down the affected power plant. Open the respective exciter field and motor cut-out switches. Care should be taken to avoid pulling heavy drags. Take proper precautions to prevent water in shut-down engine from freezing.

On locomotives equipped for multiple -unit operation it is necessary to press the reset button or rotate the reset knob projecting from the pressure-switch case. This prevents the alarm system from operating because of low lubricating-oil pressure in the shut-down engine. The pressure switch is part of the engine shut-down and alarm feature and is located on the right side of the diesel engine near the three-unit oil filter.

OPERATING WITH MOTORS CUT OUT

In case of trouble making it necessary to cut out a traction motor, the motor cut-out switch for the defective motor should be opened. Motors are numbered from end of locomotive marked "F". See Fig. 5 and Fig. 6 for location of cut-out switches.

Avoid pulling heavy loads or operating with throttle fully open when any motors are cut out. If motors No. 1 or 3 are cut out, the load indicator will give no indication.

NOTE: Operate the locomotive with traction motors cut out only in emergency.

PASSING THROUGH WATER

Do not exceed 2 or 3 mph if there is water over the rails. Never operate the locomotive through water that is more than 4-inches above the rail head.

PASSING OVER RAILROAD CROSSINGS

Partly close throttle before reaching crossing. This will reduce traction-motor current and minimize arcing at the motor commutators as the wheels jar over the crossing.

OPERATING UNDER UNUSUAL CONDITIONS

ENGINE DOES NOT TURN OVER WHEN STARTING BUTTON IS PRESSED

1. Battery, control switch, or control circuit breaker open.
2. Starting contactors GS 1 and GS2 may not be closing due to electric control connections being poor. Check connections at starting button, operating coils of starting contactors, exciter field-contactor interlocks, and control circuit breaker.
3. Battery fuse may be blown.
4. Battery may be in a low state of charge.
5. Main circuit connections may be loose or broken, or generator starting-field windings may be defective.

ENGINE TURNS OVER, BUT DOES NOT FIRE

1. Insufficient fuel supply.
2. Emergency fuel shutoff may be closed.
3. Fuel lines may be air bound -- prime them. See ENGINE INSTRUCTIONS.
4. Fuel filter or strainer may be plugged.
5. Fuel lines may be broken or fouled.

LOCOMOTIVE DOES NOT MOVE WITH ENGINE RUNNING AND THROTTLE OPEN

1. Brakes may not be released.
2. Line contactors, P 1, P 2, P3 and P4, may not be closing due to poor electric connections or because motor cut-out switches are open.
3. Main circuit electric connections may be poor. Check reverser and line contactor contacts.
4. Traction-generator excitation not building up due to exciter field cut-out switches open, or broken or slipping belts.

LOCOMOTIVE MOVES SLOWLY

1. Brakes may not be fully released.
2. All motor cut-out switches may not be in CLOSED position.
3. Traction generator may not be delivering full power. Check exciter belt tension.

LOCOMOTIVE STAYS AT LOW SPEED

Motors may not be transferring from full field to reduced field -- call maintainer for correction.

OPERATING UNDER UNUSUAL CONDITIONS

ENGINE STOPS

1. Fuel supply exhausted.
2. Emergency fuel shutoff may be closed.
3. Fuel filter or strainer may be plugged.
4. Fuel line may be broken or fouled.
5. Faulty governor or throttle linkage -- call maintainer.
6. Piston or bearing may have seized. Check by barring engine over.
7. On multiple-unit locomotives, due to low lubricating-oil pressure or high cooling water temperature.

ENGINE OVERHEATS

1. Water is low -- check for leaks and refill after permitting engine to cool.
2. Roof shutters or winter front not open sufficiently.
3. Loose fan belts.
4. Radiator is plugged (either water or air passages).
5. Low or worn-out lubricating oil.
6. Oil cooler is plugged (either oil or air passages).

BATTERY DOES NOT CHARGE

1. Battery or battery-charging-circuit fuse blown.
2. Improperly adjusted voltage-control relay -- call maintainer.

LOCOMOTIVE DOES NOT REVERSE

Wire to operating coil of magnet valve may be loose -- push magnet-valve pin, or reconnect wire.

AIR PRESSURE DOES NOT BUILD UP

1. Main-reservoir drain valve open.
2. Brake-pipe angle cock open.
3. Compressor governor stuck open -- try tapping it.
4. Compressor unloader valve stuck open -- call maintainer.
5. Slipping or broken compressor belts -- tighten or replace belts.

OPERATING UNDER UNUSUAL CONDITIONS

AIR PRESSURE BUILDS UP SLOWLY

1. Long train to charge -- advance throttle to approximately 1/2 full throttle.
2. Slipping compressor belts -- tighten belts. 3. Broken pipe or loose fittings.

BRAKES REAPPLY AFTER REGULAR RELEASE

1. Brake pipe is overcharged -- make partial brake application and return handle to RUNNING position.
2. Faulty feed valve -- call maintainer.

BRAKES HOLD AFTER RELEASE APPLICATION

1. Brake pipe undercharged or faulty distributing valve.

LOW BREAKING POWER

1. Too much brake cylinder piston travel.
2. Faulty piston.
3. Worn brake shoes.
4. Low brake cylinder pressure.
5. Broken brake cylinder pipe.

BRAKE CYLINDER PRESSURE TOO HIGH

1. Feed valve stuck or distributing valve sticks. Call maintainer.

SANDER DOES NOT WORK

1. Wet or dirty sand. Refill box with clean, dry sand.
2. Kinked hose or pockets in hose. Clean out and straighten.
3. Blocked sand pipe. Clean out pipe.
4. Broken sander. Report to maintainer.